

HDP
High Definition Printing
天然素材の味わいを生かす

訂製門組

写真板

後製門框

連工帶料



掃QR 玩配色



INTERIOR DOOR

免泥做 / 免貼皮 / 快速施工





I644

歐洲橡木



SIAA
ISO 22196
抗菌加工
Anti-Bacteria

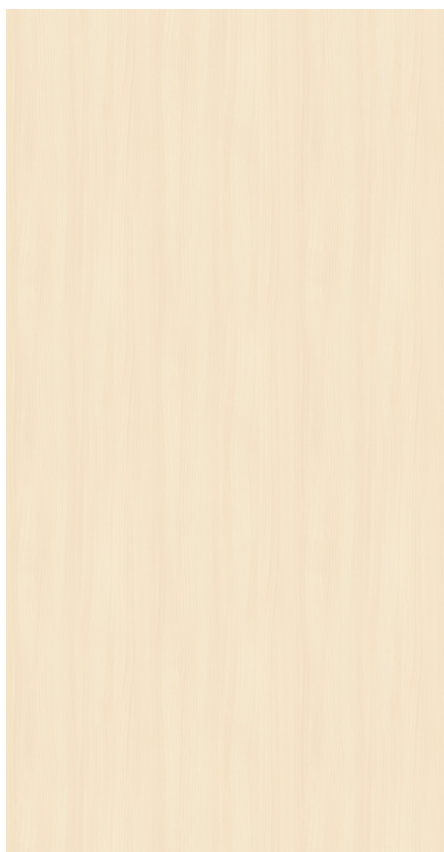

3016

熊野白樺



HDP
NANOテクノロジーで更なる進化
NANO
奈米強化







I794

皇家胡桃



I804

夜影檀木



✓ 免油漆

✓ 免塗裝

✓ 日本製造環保PP

✓ 同色收邊

✓ 不含塑化劑

✓ 防焰一級

日本聚丙烯 PP 環保面材

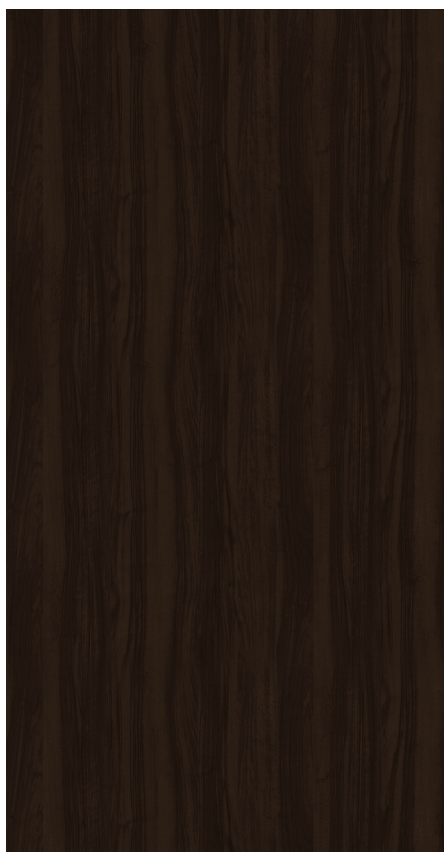
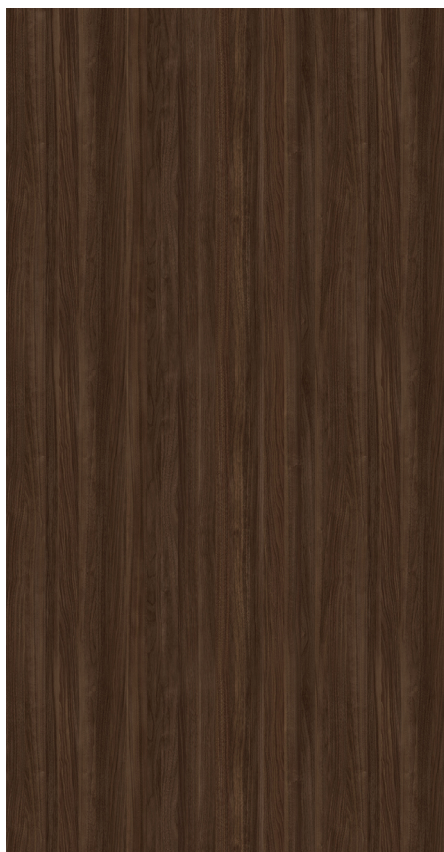

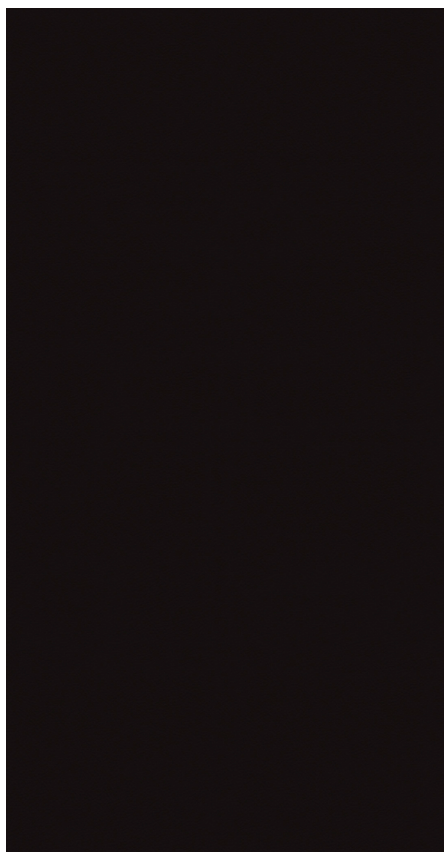

8255

摩卡黑



6446

新岳白橡



SIAA
ISO 22196
抗菌加工
Anti-Bacteria

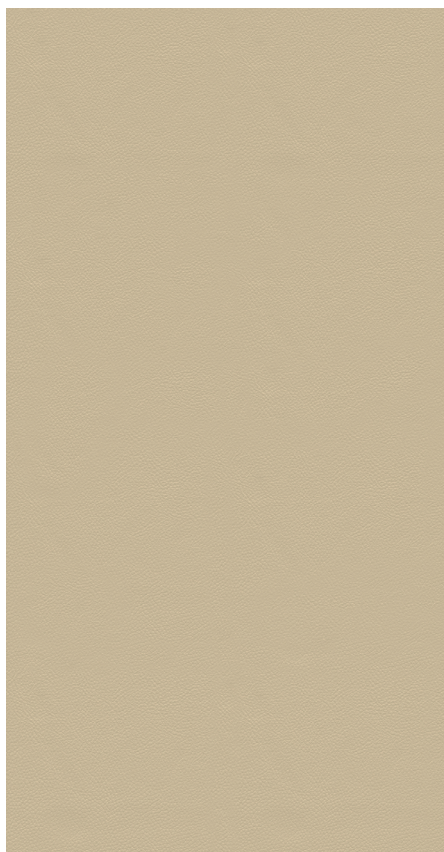

8213

拿鐵色

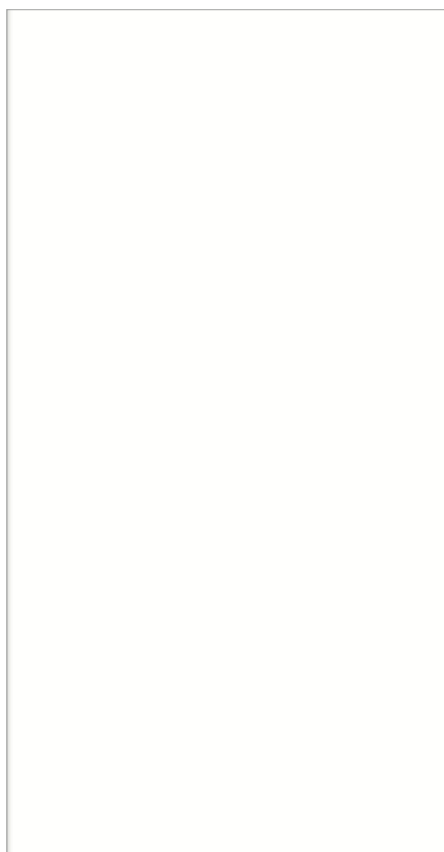

8299

霜白色





366I

加州胡桃

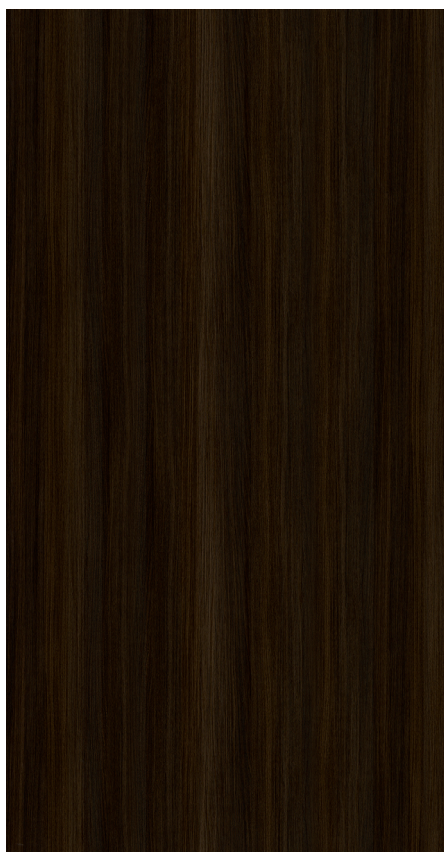

1703

幻影黑橡





2713

深紋棕橡

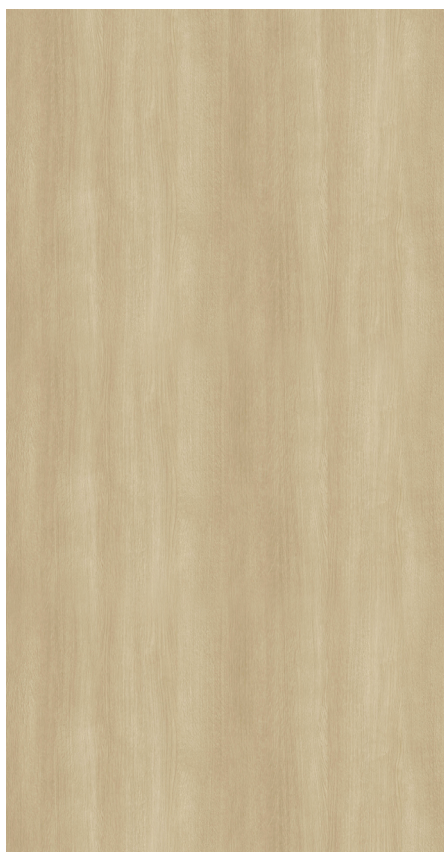

3529

信濃白橡



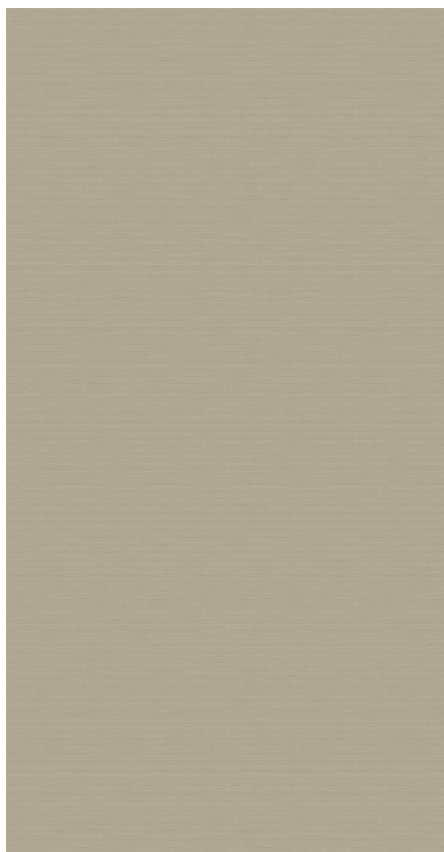

HDP 訂製門組

✓ 免油漆

✓ 免塗裝

✓ 日本製造環保PP

✓ 同色收邊

✓ 不含塑化劑

✓ 防焰一級

日本聚丙烯 PP 環保面材



1 選花色 2 填寫表單 3 安排丈量 4 施工 5 驗收完工

訂購流程

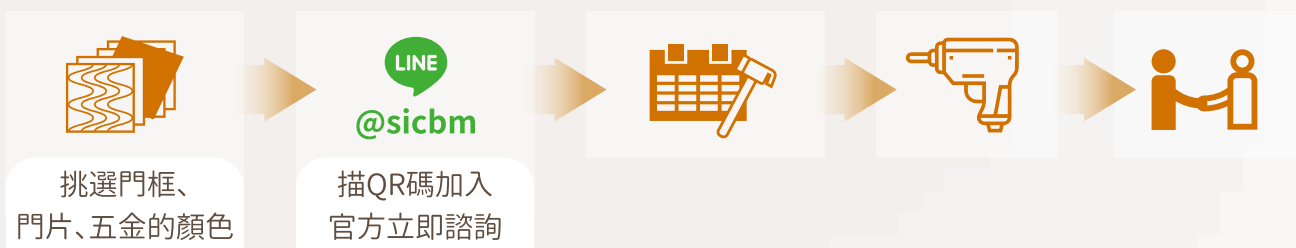

基本標配五金

銀 黑 型號 75



銀 黑 型號 76



銀 黑 型號 80



銀 黑 型號 81



銀 型號 22



門擋 銀 黑



鉸鍊 銀 黑



門組選配項目



寵物門洞



排氣孔



下降壓條

浴廁施工注意

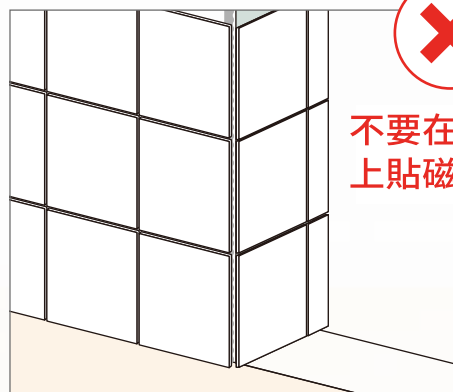
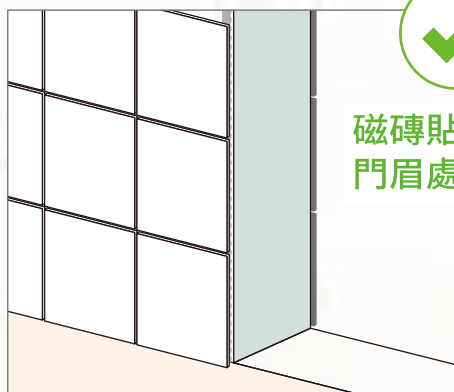
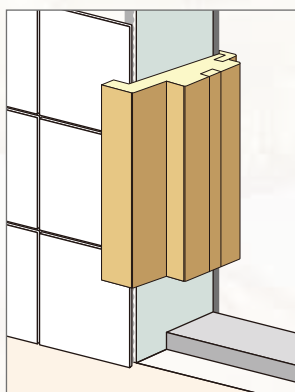

⚠ 購買安裝前請先丈量現場門洞尺寸，若超過本規格恕不退貨。本產品非 DIY 無法自行組裝，需專業施工。 ⚠

五金絞鍊

門把

HDP 後製門框

氣密條

HDP 寫真板 or 美耐板

LVL集層角料

A款 | 芯材 蜂巢結構



B款 | 芯材 隔音棉 / 岩棉



C款 | 芯材 橋洞力學板

限HDP系列



降噪功能

雲杉實木框剖面規格

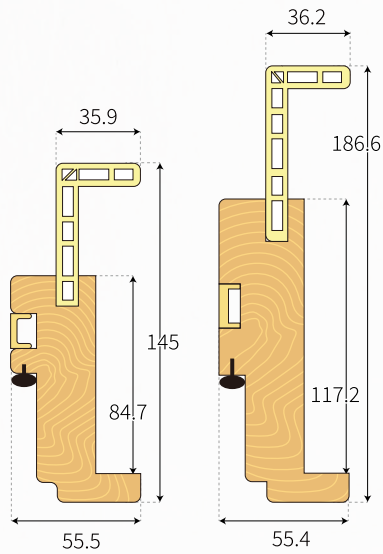

單位: mm

紐松實木框剖面規格

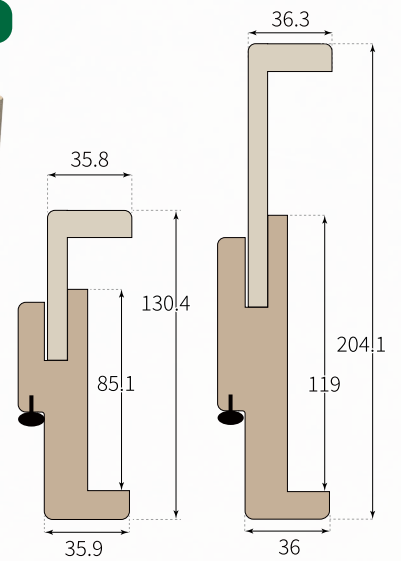

單位: mm

雲杉實木

最高 230 cm

最寬 105 cm

小框 8.5~12 cm
大框 12~16 cm

3.5 cm ~ 4.0 cm



門洞高

門洞寬

牆厚

門片厚

紐松實木

最高 240 cm

最寬 120 cm

小框 8.5~12 cm
大框 12~20 cm

3.5 cm ~ 4.0 cm

